

Dental Radiography Series



Successful
Intraoral Radiography





Successful Intraoral Radiography

Every dental professional would like to achieve the goal of producing consistent, quality intraoral radiographs. A quality intraoral radiograph will reveal maximum image detail with anatomic accuracy and optimal density and contrast, providing the highest diagnostic yield. This pamphlet will address some of the common errors in capturing and processing intraoral radiographs and explain how to prevent and correct them. For similar information on panoramic radiography, please refer to the publication entitled "Successful Panoramic Radiography".

Quality Radiography

The goal of all radiography should be to produce a high quality radiograph. Such a radiograph will exhibit maximum detail to resolve fine objects. It will show the teeth and anatomic structures accurately without distortion or magnification. It will have the optimal density and contrast (visual characteristics) to maximize its use for the detection of dental disease. To create such a film, the dental staff must pay attention to all three steps in the production of the radiograph including: positioning, exposure and processing.

First, the film must be properly positioned to ensure proper geometry and prevent distortion and overlap. Second, the exposure technique factors must be appropriate for the patient and the film selected. And last, proper processing time, temperature and handling requirements must be followed to produce a quality radiograph.

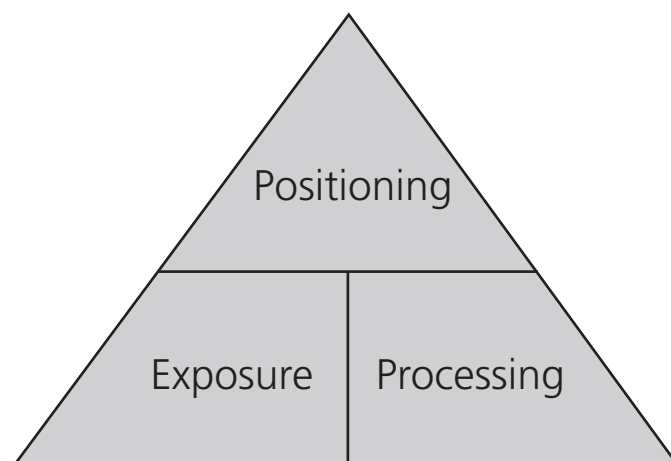

Figure 1 Three steps In producing a quality radiograph

Proper Film Positioning

Step 1: Proper Film Positioning

Film placement for proper anatomic coverage is beyond the scope of this pamphlet and can be reviewed in any quality dental radiography text. This document will discuss improper film placement that can lead to errors such as overlapped contacts and distorted teeth and roots. These problems occur due to the fact that dental radiography is a shadow casting technique. In other words, we cast an image of the tooth onto the film. Shadow casting can cause geometric distortions in the final radiograph such as elongation, magnification and overlapping contacts.

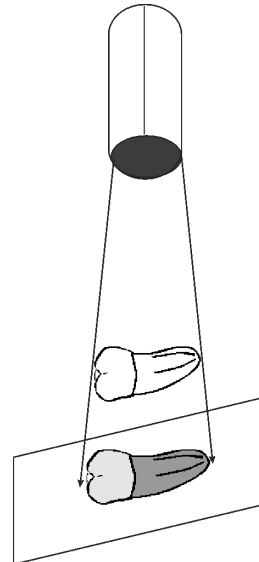

Figure 2 Shadow casting

Figure 3 Excessive vertical angulation, note inferior border of mandible visible, elongation of roots. Correct by moving film further back into the mouth



Geometric distortion can be minimized by using a long x-ray source to object distance. This can be obtained using a long cone (40 cm/16 inch) technique. Geometric distortion can also occur if the film is not at right angles to the beam. For this reason, it is recommended to always use a film-holding and position indicating device (PID). Many practitioners assume these devices can control all angulation problems; however, they merely hold the film perpendicular to the x-ray beam. They do not totally prevent errors in the vertical and horizontal angulation of the film to the tooth itself. This can lead to commonly seen errors of overlapped contacts and vertical distortion of teeth on the radiograph. These issues can be minimized by proper use of the paralleling technique.

Figure 4 Distortion from film bending in corner of arch. Correct by placing film further into center of the mouth

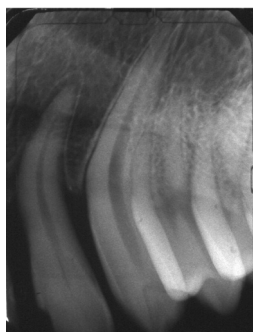

Figure 5 Bent film corners causing black lines on film. Correct with proper film placement, use soft film packets. Handle film packets as carefully as possible



Distortion (vertical angulation)

Although film-holding devices position the film at right angles to the x-ray beam, they do not prevent rotation of the whole device in a vertical axis. This rotation places the film at an angle to the tooth and can result in distortion when the angle is significant. This commonly occurs when the film is not placed far enough in the center of the mouth and the film must be angulated to avoid the slope of the palate or the mandibular vestibule. It can be avoided by simply placing the film deeper into the center of the mouth so that tipping is not necessary. Another type of distortion occurs when the film is bent when the patient bites down. This can also be avoided by placing the film deep enough into the mouth to avoid contact with the palate. Bending of film corners for patient comfort can also cause errors, as the pressure of the bend can cause partial film development. These bends appear as black lines on the film.

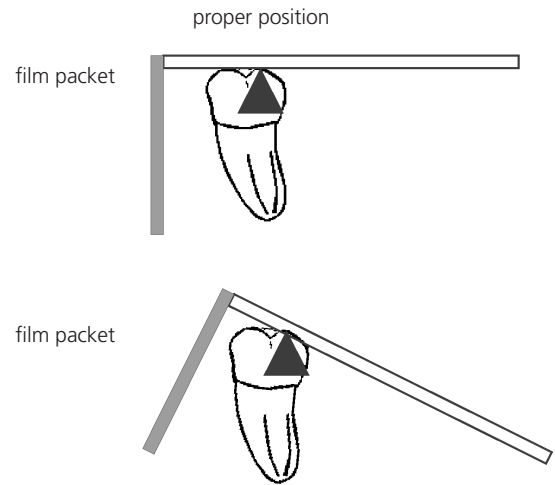

Figure 6 Vertical angulation due to fulcrum rotation on lower molar

Overlapped contacts (horizontal angulation)

In order to maximize the amount of contact opening, the beam should be directed at right angles to the contact area. In the mandible this is fairly straightforward. In the maxilla, however, the molar contacts are often directed mesially due to the triangular shape of the maxillary molars. This means that the beam must also be directed from the mesial to open these contacts. Often times the reverse is done. The beam is directed from the mesial in the bicuspid area and at right angles or distal in the molar region. This will most often result in overlapped contacts. Contact areas should always be visualized prior to taking bitewing radiographs.

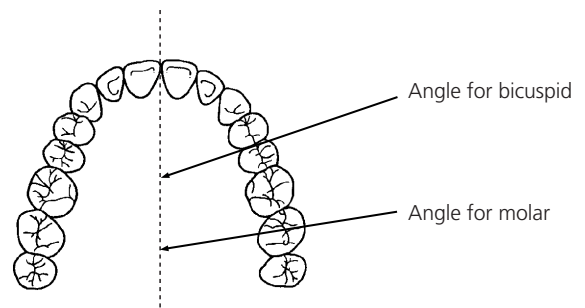

Figure 9

Figure 7 Improper horizontal angulation, contacts overlapped



Figure 8 Proper horizontal angulation, contacts open



Cone cuts

Dental x-ray beams are collimated or restricted to a diameter of 7 cm/2.75 inches at the end of the cone or even less when a rectangular collimator is used. When the exit pattern of the beam is not aligned with the film, part of the film will not be exposed to radiation and will appear clear. This is known as a cone cut. Proper use of position indicating devices (PIDs) will help to prevent these cone cuts, which can occur with either round or rectangular cones.

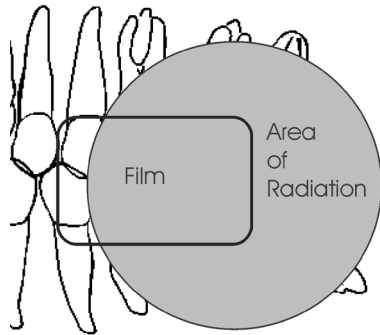

Figure 10

Reversed films

Dental x-ray film is marked with an indicator dot to help indicate the tube side of the film and to help distinguish the patient's right or left side. In addition, the film packet contains a sheet of lead foil which prevents unnecessary radiation from passing through into the patient and reduces scatter radiation. This sheet of lead foil is marked with a special pattern. When a film is exposed from the wrong side, the pattern is visible on the radiograph. Due to the attenuation of the foil, the radiograph also appears overall light in density.

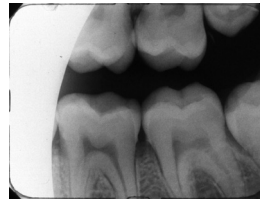

Figure 11 Cone cut using round cone

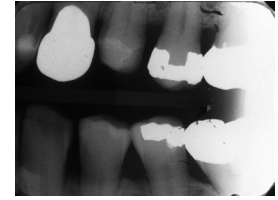

Figure 12 Cone cut using rectangular cone

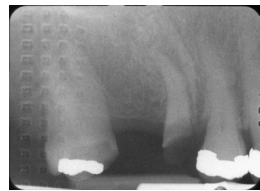

Figure 13 Reversed film, note dot pattern on left edge of radiograph, light overall density



Figure 14 Foil from packet showing pattern of dots

Radiograph	Error	Fix
Teeth elongated or shortened, cusps don't overlap, sinus structures or inferior border of mandible visible	Excessive vertical angulation	Correct film placement and reduce vertical angulation
Contacts of teeth overlapped	Improper horizontal angulation	Visualize contact area and adjust
Dark lines on film	Film bent	Use of Carestream Dental Poly-Soft packets and proper placement to minimize any bending. Open packet without excessive bending
Clear area on one edge of film either in arc or straight	Cone cut	Align cone with position indicating device
Film light in density, unusual pattern across film ("tire tracks" "herringbone")	Packet was reversed and exposed through the back side, pattern is for orientation from foil inside packet	Follow instructions on packet for proper orientation

Table 1 Film positioning errors

Film Exposure

Step 2: Film Exposure

Selecting a Film

Film selection is important to both radiographic success and to provide the lowest practical exposure to the patient. To achieve consistent quality radiographs you must use a consistent quality film. Low cost films may vary from batch to batch or may come from different manufacturers. This makes establishing consistent exposure and development technique factors very difficult. Dental films are provided in different speed groups. D-speed films are the slowest speed films and F-speed films are the fastest.

INSIGHT dental film is an F-speed film that can provide an additional 20% reduction in exposure over E-speed films (and a 60% reduction in exposure over D-speed films) with consistent image contrast and quality. In accordance with the ALARA principle (keep doses As Low As Reasonably Achievable), the use of F-speed film is highly encouraged. For helpful exposure guidelines, please see pages 11 and 12. Using these guidelines, the practitioner can verify that their exposure factors are within the suggested normal ranges for good radiographic techniques.

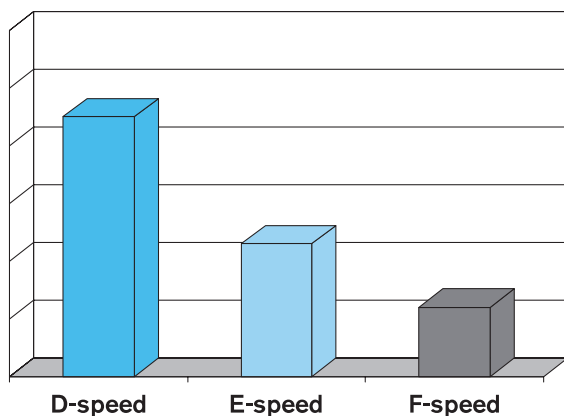

Figure 15 Exposure time, F-speed represents a 60% reduction in exposure over D-speed film

Influence of milliamperes

Most modern dental x-ray machines no longer allow for the adjustment of mA or milliamperage. Since the effect of increasing or decreasing mA is the same as for exposure time, it is common to combine the two and talk of mAs or milliamp-seconds. In dentistry we are mainly concerned with exposure time as discussed below.

Influence of time

Film density (how light or dark the overall film is) is directly related to exposure time. The longer the exposure time the more x-ray photons reach the film and expose it. Therefore, the film is darker. The x-ray timer can be thought of as a faucet. It turns the flow of x-rays on or off. If you open the faucet twice as long, you will get twice as many x-rays out of the machine. If you double the time, the film will be approximately twice as dark.



Figure 16 Exposure time is like a faucet



Figure 17 0.25 second exposure (underexposed)



Figure 18 0.5 second exposure (properly exposed)

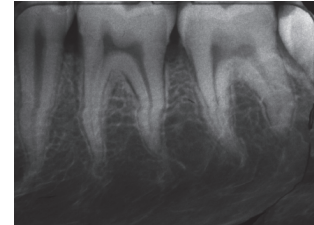

Figure 19 1.0 - second exposure (over exposed)

Radiograph	Exposure Time	Fix
Too dark	Too long	Use shorter time, fewer impulses
Too light	Too short	Use longer time, longer impulses

Table 2 Exposure time errors

Influence of peak kilovoltage

Many modern dental x-ray machines no longer allow the adjustment of peak kilovoltage (kVp). The kilovoltage affects both the quantity of the x-rays produced and their average energy. The average energy is sometimes referred to as the "beam quality." The effect of peak kilovoltage can be compared to a spray nozzle. It controls the force of the emerging stream of x-rays, while the faucet (timer) controls the volume.

kVp has two effects on the quality of the final radiograph. First, it affects the contrast or gray scale. Low kVp is like opening the nozzle. The lower energy x-rays have less penetrating power. This provides a high contrast image with an obvious black and white appearance. High kVp is like closing the nozzle. The beam is "harder" with higher energy. High kVp gives a low contrast image, but with more shades of gray to show subtle contrast changes. Second, using higher kVp produces more x-rays. This is not a linear relationship, but rather the density of the film varies as the square of the kVp. A good standard to follow is:

An increase of 10 kVp => Divide exposure time by 2

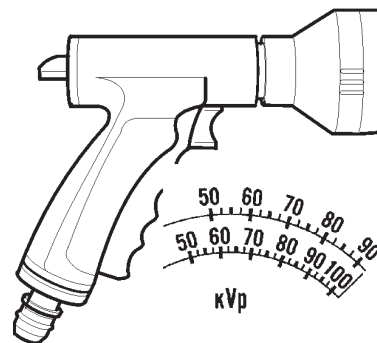

Figure 20 kV is like a spray nozzle

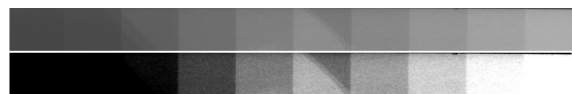

Figure 21 Low contrast long gray scale above, high contrast short gray scale below

An increase of 15 kVp = 2 X an Increase in Density

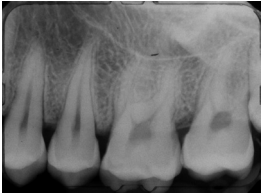

Figure 22 55 KvP



Figure 23 70 KvP



Figure 24 85 KvP

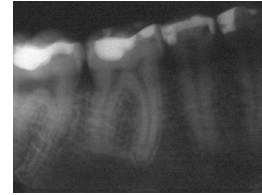

Figure 25 Film mistakenly shot at 90 KvP, all other exposure factors were set as normal

Although many modern x-ray machines do not allow changes in kVp, modern DC (direct current) machines are actually equivalent to older machines operating at higher voltages. For example, a modern 70 kVp DC machine has a beam quality similar to an older 80 kVp machine.

Other errors that can occur during exposure include patient movement and double exposures. The best way to avoid patient movement is to use an F-speed film to achieve a short exposure time. Another way to decrease patient movement errors is to be sure a headrest stabilizes the patient's head during film placement and exposure. Double exposures are usually caused by operator inattention. Keep unexposed films separated from exposed films to help alleviate this problem. It is important to note that when a double exposure occurs there is usually a corresponding blank film in the series.

Radiograph	kV Setting
Too dark	Too high
Too light	Too low
Too much contrast	Too low
Too washed out	Too high

Table 3 kVp errors

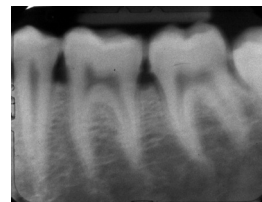

Figure 26 Patient movement, note blurring of image, soft focus

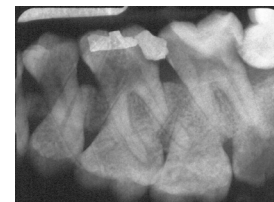

Figure 27 Double exposure, not multiple images of teeth

Radiograph	Error	Fix
Blurring of structures	Patient movement	Use F-speed film for shorter exposure times. Remind patient to hold still and use a head rest. Tube movement is not as adverse as patient movement.
Multiple images on film	Double exposure	Exposed films should always be separated from unexposed film while taking radiographs.

Table 4 Errors during exposure

Recommended exposure settings for Carestream Dental intraoral films

Ultra-speed*

		Settings	kV	60	65	65	65	70	70	70	80
			mA	7	7.5	8	10	7	8	10	10
20 cm/8 inches	Maxillary	Incisor		0.55	0.32	0.30	0.24	0.27	0.24	0.19	0.10
		Cuspid		0.55	0.32	0.30	0.24	0.27	0.24	0.19	0.10
		Bicuspid		0.73	0.43	0.40	0.32	0.37	0.32	0.26	0.13
		Molar		0.82	0.48	0.45	0.36	0.41	0.36	0.29	0.14
	Mandibular	Incisor		0.46	0.27	0.25	0.20	0.23	0.20	0.16	0.08
		Cuspid		0.46	0.27	0.25	0.20	0.23	0.20	0.16	0.08
		Bicuspid		0.50	0.29	0.28	0.22	0.25	0.22	0.18	0.09
		Molar		0.55	0.32	0.30	0.24	0.27	0.24	0.19	0.10
	Bite-Wing	Anterior (Incisor)		0.46	0.27	0.25	0.20	0.23	0.20	0.16	0.08
		Posterior (Bicuspid)		0.55	0.32	0.30	0.24	0.27	0.24	0.19	0.10
	Occlusal			0.91	0.53	0.50	0.40	0.46	0.40	0.32	0.16
	40 cm/16 inches	Maxillary	Incisor		2.19	1.28	1.20	0.96	1.10	0.96	0.77
Cuspid				2.19	1.28	1.20	0.96	1.10	0.96	0.77	0.38
Bicuspid				2.93	1.71	1.60	1.28	1.46	1.28	1.02	0.51
Molar				3.29	1.92	1.80	1.44	1.65	1.44	1.15	0.58
Mandibular		Incisor		1.83	1.07	1.00	0.80	0.91	0.80	0.64	0.32
		Cuspid		1.83	1.07	1.00	0.80	0.91	0.80	0.64	0.32
		Bicuspid		2.01	1.17	1.10	0.88	1.01	0.88	0.70	0.35
		Molar		2.19	1.28	1.20	0.96	1.10	0.96	0.77	0.38
Bite-Wing		Anterior (Incisor)		1.83	1.07	1.00	0.80	0.91	0.80	0.64	0.32
		Posterior (Bicuspid)		2.19	1.28	1.20	0.96	1.10	0.96	0.77	0.38
Occlusal				3.64	2.12	2.00	1.60	1.84	1.60	1.28	0.64

*Class: D-speed

Note: for large patients increase time by approximately 25%; for children and / or small patients decrease time by approximately 30%; to convert to impulses, multiply by 60.

INSIGHT*

		Settings	kV	60	65	65	65	70	70	70	80
			mA	7	7.5	8	10	7	8	10	10
20 cm/8 inches	Maxillary	Incisor		0.25	0.14	0.14	0.11	0.12	0.11	0.09	0.04
		Cuspid		0.25	0.14	0.14	0.11	0.12	0.11	0.09	0.04
		Bicuspid		0.33	0.19	0.18	0.14	0.16	0.14	0.12	0.06
		Molar		0.37	0.22	0.20	0.16	0.19	0.16	0.13	0.06
	Mandibular	Incisor		0.21	0.12	0.11	0.09	0.10	0.09	0.07	0.04
		Cuspid		0.21	0.12	0.11	0.09	0.10	0.09	0.07	0.04
		Bicuspid		0.23	0.13	0.12	0.10	0.11	0.10	0.08	0.04
		Molar		0.25	0.14	0.14	0.11	0.12	0.11	0.09	0.04
	Bite-Wing	Anterior (Incisor)		0.21	0.12	0.11	0.09	0.10	0.09	0.07	0.04
		Posterior (Bicuspid)		0.25	0.14	0.14	0.11	0.12	0.11	0.09	0.04
	Occlusal			0.41	0.24	0.23	0.18	0.21	0.18	0.14	0.07
	40 cm/16 inches	Maxillary	Incisor		0.99	0.58	0.54	0.43	0.49	0.43	0.35
Cuspid				0.99	0.58	0.54	0.43	0.49	0.43	0.35	0.17
Bicuspid				1.32	0.77	0.72	0.58	0.66	0.58	0.46	0.23
Molar				1.48	0.86	0.81	0.65	0.74	0.65	0.52	0.26
Mandibular		Incisor		0.82	0.48	0.45	0.36	0.41	0.36	0.29	0.14
		Cuspid		0.82	0.48	0.45	0.36	0.41	0.36	0.29	0.14
		Bicuspid		0.91	0.53	0.50	0.40	0.45	0.40	0.32	0.16
		Molar		0.99	0.58	0.54	0.43	0.49	0.43	0.35	0.17
Bite-Wing		Anterior (Incisor)		0.82	0.48	0.45	0.36	0.41	0.36	0.29	0.14
		Posterior (Bicuspid)		0.99	0.58	0.54	0.43	0.49	0.43	0.35	0.17
Occlusal				1.65	0.96	0.90	0.72	0.82	0.72	0.58	0.29

*Class: F-speed

Note: For large patients increase time by approximately 25%; for children and / or small patients decrease time by approximately 30%; to convert to impulses, multiply by 60.

In manual processing environment, the film is E-speed. Increase exposure time by approximately 20%.

Processing

Step 3: Processing Development

Even with the excellent automatic processors available today, many errors can occur during film processing. Many of these errors are due to improper film handling, but some can be caused by the processor itself. Processing is a chemical reaction therefore:

INCREASED TEMPERATURE = INCREASED DEVELOPMENT = DARKER FILM

INCREASED TIME = INCREASED DEVELOPMENT = DARKER FILM

For these reasons, the manufacturer's recommendations for development time and temperature should be closely followed. Automatic processors should still be checked for developer temperature as heating elements can fail or overheat. Proper attention to chemical dilution, mixing and loading must also be followed. Fixer should always be poured first into the processor as a small spill of fixer into the developer can drastically weaken the developer:

CONTAMINATED OR DEPLETED CHEMISTRY = INCOMPLETE DEVELOPMENT = LIGHT FILM

Developer must be replenished following manufacturer's recommendations or it will become exhausted. These recommendations are usually based on the amount of radiographs processed. However, developer exhaustion is determined by the surface area of the films processed not the number of films. For example, if large numbers of panoramic or cephalometric films are processed, more frequent replenishment will be needed.

Radiograph	Problem	Fix
Too light	Temperature too low or time too short	Check temperature and adjust development time as needed
Too dark	Temperature too high or time too long	Check temperature and adjust development time as needed
Too light	Contaminated or weak developer	Replace or replenish developer. Follow dilution instructions
Too dark (fogging)	Over concentrated developer	Follow dilution instructions

Table 5 Processing errors

Manual Processing of Intraoral Carestream Dental Films

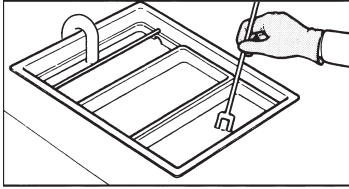

1 STIR SOLUTIONS

Dilute developer and fixer solutions as directed on the containers. Use separate paddles for each solution to avoid possible contamination. Stir the solutions gently. This ensures uniformity of solutions and temperatures.

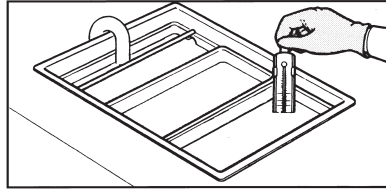

2 CHECK TEMPERATURES OF SOLUTIONS

Check temperatures of solutions with an accurate thermometer. Rinse the thermometer thoroughly in running water before checking the other solution. Developer temperature should be within 20-24 °C. Fixer temperature should be within 15-30 °C.

Temperature	Developing time (min)
20°C	5
22°C	4
24°C	3

3 CHECK DEVELOPMENT TIME

Refer to the table above and check the development time based on the temperature of the developer in preparation for step 5.

The times in the table are recommended for use with GBX Dental Developer.

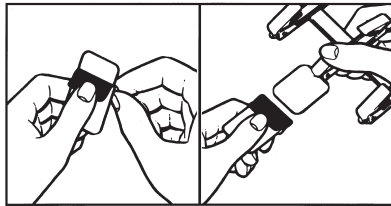

4 LOAD FILM ON HANGER

Remove films from packets and attach carefully to a multiple-clip hanger, avoid finger-marks, scratching or bending.

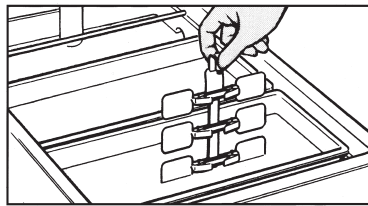

5 IMMERSE FILMS IN DEVELOPER AND START TIMING

Immerse the films smoothly and without pause; this minimizes streaking. Start timing.

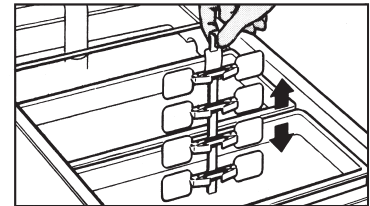

6 AGITATE FILMS

Dislodge air bubbles by vigorously moving film hanger in solution for 5 seconds. Do not raise out of the developer solution.

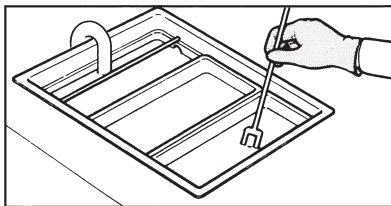

7 RINSE THOROUGHLY

At the end of development time, quickly remove hanger from the developer and place in wash section for 30 seconds with clean running water at a temperature of 15-30 °C. Lift from water and allow to drain over the wash section.

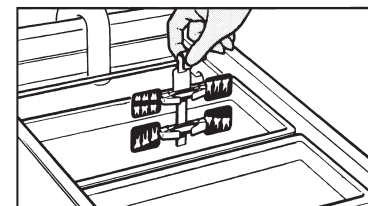

8 FIX ADEQUATELY

Place films in the fixer solution and agitate the hanger continuously for 2-4 minutes. See specific instructions for fixing times and temperatures.

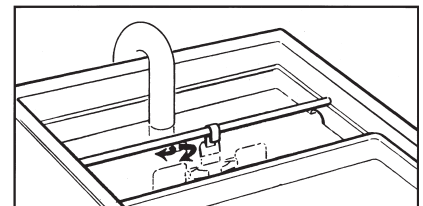

9 WASH THOROUGHLY

Remove hanger from fixer and place in wash section. Wash for 10 minutes in running water. Eight volume changes per hour are recommended. Extraoral film should be washed for 5 minutes.

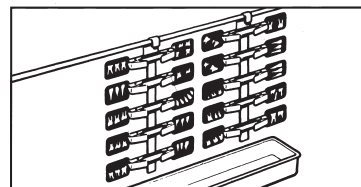

10 DRY

Suspend hanger from a drying rack in dust-free area. Use a fan to accelerate drying. When dry, remove films from hanger, mount and identify.

Note: The times indicated are appropriate with correct exposure time of the intraoral films.

Handling

Film must be handled carefully under proper safelight conditions during processing. Most dental films recommend red safety filters such as GBX-2 safelight filter. If a daylight loader is used in a brightly lit room, the use of another type of filter can result in film fogging. Care must also be taken when feeding film into a processor. Opening the lid too soon on a daylight loader can result in room light fogging the trailing edge of the film.

It can take up to 15-20 seconds for film to completely enter an automatic processor. Film fed too quickly or too close together can overlap or stick together. Other errors can occur from emulsion tears, fingerprints, static electricity and chemical spills onto the film. Only clean, dry,

powder-free gloves should contact the bare film prior to processing. Unprocessed film should not come in contact with wet or contaminated surfaces as this may lead to film spotting.

Carestream Dental Films with a ClinAsept barrier not only aids in infection control but also allows film to be handled with clean hands after removal from the barrier envelope, preventing discoloration and cross-contamination.

After processing, films must not come into contact until completely dry as the wet emulsions can stick together and peel off the films when they are separated.



Figure 28 Emulsion tear, note white area under pontic where no emulsion is left



Figure 29 Fingerprint, dirty finger had fixer on it leaving white mark on film



Figure 30 Overlap of films during processing

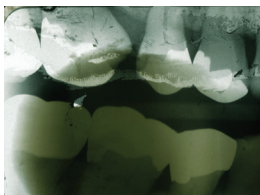

Figure 31 Stain from incomplete film fixing/washing or exhausted fixer



Figure 32 Light fog on left edge of film from opening lid on daylight loader too soon

Handling Errors

Radiograph	Handling Problem	Fix
Too dark (similar to fogging)	Improper safelight	Use GBX-2 Safelight Filters or filter with wavelength >520 nm
Random sized dark spots: v shaped, mottle "noise"	Stored in humid or hot conditions	Store film between 10 to 24 °C (50-75 °F) and between 30-50% rH.
Dark rectangle on film	Overlap during processing	Feed films slowly or side by side
Dark edge on film	Exposed to light before safely in processor	Allow 15-30 seconds from last film to enter processor. Listen for click or watch for ready light on processor to indicate when safe to feed next film
Fingerprints	Improper handling	Clean, dry hands and hold the film on the edges
Dark spots	Developer stains	Keep darkroom clean, wipe up any spilled chemistry to avoid spotting films
White spots	Fixer stains	Keep darkroom clean, wipe up any spilled chemistry to avoid spotting films
Streaks or scratches	Emulsion tears	Never allow wet films to contact one another or fingernails, emulsion is delicate when wet. Keep films away from extreme sides of processor
Dark spots or lines in a pattern	Roller marks	Use Roller Transport Clean-up Film daily and/or clean rollers with mild detergent and rinse thoroughly
Dark spots-branched or dots	Static (most common in winter months)	Add humidifier and or open packets slowly to minimize static discharge. Do not refrigerate film
Yellowish color	Poor fixing/washing or exhausted fixer	Change chemistry

Summary of Intraoral Errors

Problem	Error and Fix
Teeth elongated, cusps don't overlap, sinus structures or inferior border of mandible visible	Excessive vertical angulation, correct film placement
Contacts of teeth overlapped	Improper horizontal angulation, visualize contact area and adjust
Dark lines on corner of film	Film bent, use of Carestream Dental Poly-Soft packets and proper placement to reduce bending
Clear area on one edge of the film either in arc or straight	Cone cut, use position indicating device
Film light in density, unusual pattern across film ("tire tracks" or "herringbone")	Film was reversed and exposed through the back side, pattern is from lead foil, assure correct side toward tube
Too dark	Exposure too long, shorten time kV too high, reduce kV Processor temperature too high, reduce temperature Development time too long, shorten time Over concentrated developer, follow dilution directions Improper safelight, follow recommendations
Too light	Exposure too short, lengthen time kV too low, raise kV Processor temperature too low, raise temperature Development time too short, increase time Contaminated or weak developer (replace or replenish solutions)
Too much contrast	kV low, adjust kv
Too washed out or gray	kV high, adjust kV
Blurring of structures	Patient movement, use F-speed film for shorter exposure time. Use head rest.
Multiple images on film	Double exposure, separate exposed packets from unexposed packets
Mottle "noise"	Stored in humid or hot conditions, store as directed on package
Dark rectangular area on film	Overlap during processing, feed as directed
Dark edge on film	Exposed to light before safely in processor, do not open or turn on light too soon
Fingerprints	Clean, dry hands and hold the film on the edges
Dark spots	Developer stains, practice darkroom cleanliness
White spots	Fixer stains, practice darkroom cleanliness
Clear streaks, splotches or scratches	Emulsion tears, keep separated while wet
Dark spots in pattern	Dirty processor rollers, clean processor daily
Dark spots branched or dots	Static due to over-dry conditions, adjust humidity, open packets slowly

Carestream Dental Chemistry*

Chemistry for manual processing

Product	Processing	Ready to Use or Concentrate
Rapid Access Developer Rapid Access Fixer Rapid Access Twin Pack	Developing: 15 sec. 20°C/68°F Fixing: 15 sec.** 20°C/68°F Wash: 1 - 2 min. 20°C/68°F (for archiving refix and wash as directed)	Ready to use
GBX Developer and Replenisher GBX Fixer and Replenisher GBX Twin Pack	Developing: 5 min. 20°C/68°F 4 1/2 min. 21°C/70°F 4 min. 22°C/72°F 3 min. 24.5°C/76°F 2 1/2 min. 26.5°C/80°F Rinse: 30 sec. agitating continuously Fixing: 2-4 min. or 2X clearing time with intermittent agitation 15.5-29.5°C/60-68°F Wash: 10 min. in running water	Concentrate – requires dilution follow instructions on product
GBX Developer and Replenisher	see above	Concentrate – requires dilution follow instructions on product
GBX Fixer and Replenisher	see above	Concentrate – requires dilution follow instructions on product

Carestream Dental chemistry for automatic processing

Product	Processing	Ready to Use
READYMATIC Chem Pack	See processor's manual	Ready to use. Roller type processor
READYMATIC Developer and Replenisher	See processor's manual	Ready to use. Roller type processor
READYMATIC Fixer and Replenisher	See processor's manual	Ready to use. Roller type processor
READYPRO Twin Pack	See processor's manual	Ready to use. Rollerless type processor

*Check with distributor for availability in your area. All chemistries are not available in all countries.

**May need extra if near end of solution potency.



Ordering Information for INSIGHT Film

Size	Description	Code	Films/Pkgs	REF No
Size 0	Super Poly-Soft packets	IP-01	100	867 5332
Size 0	Super Poly-Soft packets (double film)	IP-02	100	128 0619
Size 0	Super Poly-Soft packets with ClinAsept barrier	IP-01C	75	120 0328
Size 1	Paper packets	IP-11	100	112 4981
Size 1	Paper packets (double film)	IP-12	100	805 5402
Size 2	Super Poly-Soft packets	IP-21	150	116 3401
Size 2	Super Poly-Soft packets (double film)	IP-22	130	179 8628
Size 2	Super Poly-Soft packets with ClinAsept barrier	IP-21C	100	153 9931
Size 2	Super Poly-Soft packets with ClinAsept barrier (double film)	IP-22C	100	156 0390
Size 2	Paper packets	IP-21	150	176 3960
Size 2	Paper packets (double film)	IP-22	150	107 9086
Size 2	Bite-wing paper packets	IB-21	50	180 7650
Size 3	Bite-wing paper packets	IB-31	100	829 8929
Size 4	Occlusal paper packets	IO-41	25	116 9143

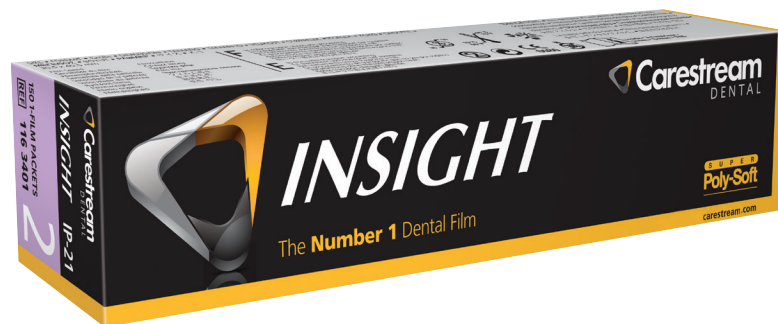

Ordering Information for Ultra-speed

Size	Description	Code	Packets/Package	REF No
Size 0	Super Poly-Soft packets	DF-54	100	122 8840
Size 0	Super Poly-Soft packets (double film)	DF-53	100	122 8931
Size 0	Super Poly-Soft packets with ClinAsept barrier	DF-54C	75	144 5360
Size 1	Paper packets	DF-56	100	127 3747
Size 1	Paper packets (double film)	DF-55	100	127 3721
Size 2	Super Poly-Soft packets	DF-58	150	165 8194
Size 2	Super Poly-Soft packets (double film)	DF-57	130	175 3664
Size 2	Paper packets	DF-58	150	149 1737
Size 2	Paper packets (double film)	DF-57	150	149 1752
Size 2	Bite-wing paper packets	DF-40	50	839 3043
Size 2	Super Poly-Soft packets with ClinAsept barrier	DF-58C	100	171 7131
Size 2	Super Poly-Soft packets with ClinAsept barrier (double film)	DF-57C	100	898 7877
Size 3	Bite-wing paper packets	DF-42	100	129 6771
Size 4	Occlusal paper packets	DF-50	25	166 6163

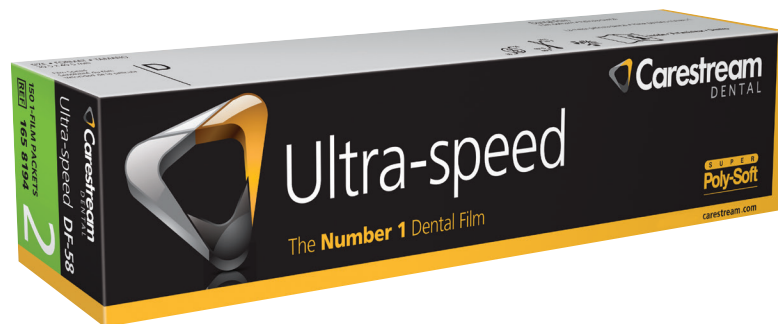

Other Publications in the Dental Radiography Series

- Exposure and Processing in Dental Film Radiography
- Guidelines for Prescribing Dental Radiographs
- Radiation Safety in Dental Radiography
- Successful Panoramic Radiography
- Quality Assurance in Dental Film Radiography

Would you like to know more?

For more information, call **800.933.8031** or visit **carestream.com**.